

Installation Precautions:

1. Please read through the Instructions before installation.;
2. The luminaire is used in the W2 three-phase rail system or in other company brands with compatible rails,
 Guide rail parameters: Input voltage: AC 220-240V Maximum current: 16A Maximum load: 3680W;
3. Installed by a qualified electrician;
4. To avoid the risk of electric shock, ensure that the power supply is turned off before installation and maintenance;
5. Suitable for indoor installation (not for humid environment);
6. The light source of this lamp is not replaceable, once it needs to be replaced (such as the end of the life of the light source), the entire lamp should be replaced;
7. Luminaries and dimming systems need to be tested for compatibility in advance;
8. Keep this manual safe for use when needed.

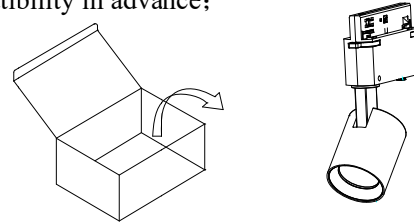

One Assemble the rail light connector.

1. Before assembly, ensure that the locking handle is in the "UNLOCK" state and the commutating handle is in the "0" state.

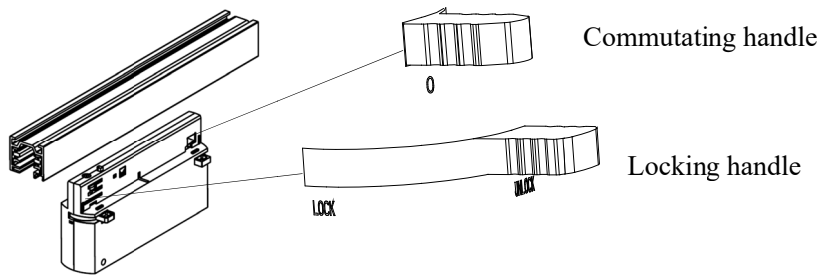

2. Align the boss of the guide light connector with the groove of the guide rail before assembly.

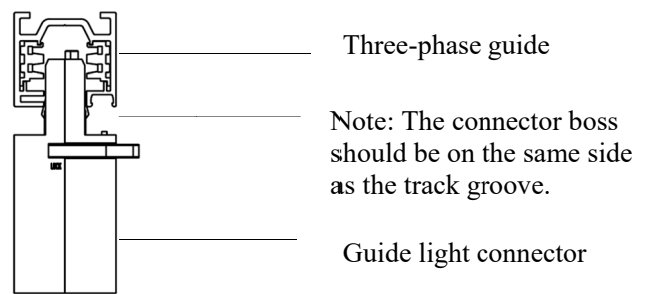

3. After the assembly is complete, turn the LOCK handle clockwise from "UNLOCK" to "LOCK".

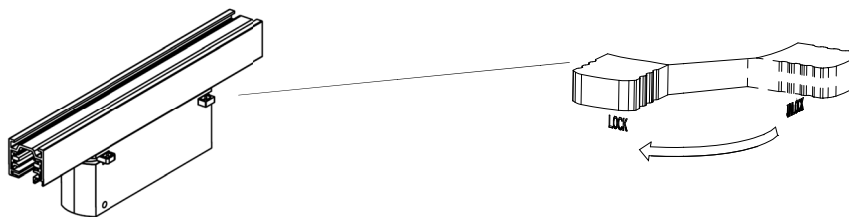

Two. Commutation regulation:

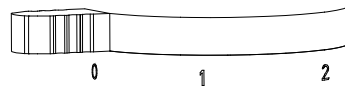
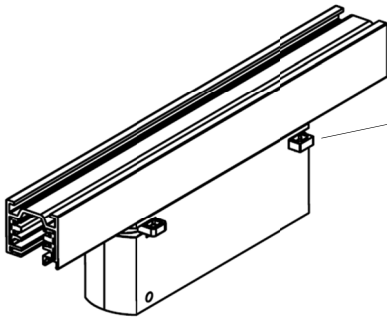

- 0 indicates that the guide rail connector is not connected to power supply
- 1 indicates that the guide rail connector is connected to phase 1 of the guide rail
- 2 indicates that the guide rail connector is connected to phase 2 of the guide rail
- 3 indicates that the guide rail connector is connected to phase 3 of the guide rail

Three. Remove guide light connector:

1. Switch the state of the commutator handle to "0" before removing it.

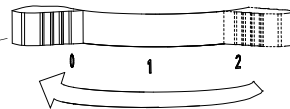
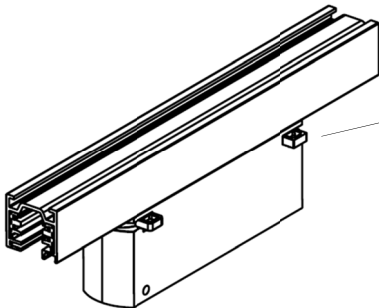

2. Then turn the LOCK handle counterclockwise to switch from "LOCK" to "UNLOCK".

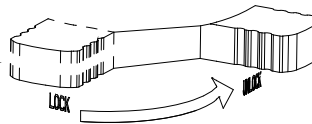
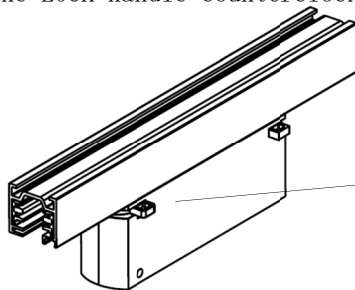

3. Finally, pull down one end of the guide light connector to remove the entire guide light connector.

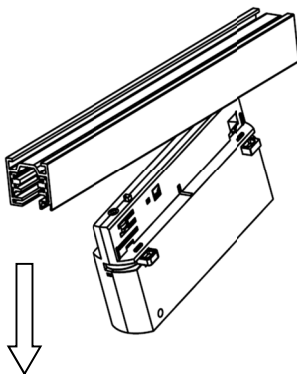

Four. Luminaire regulation:

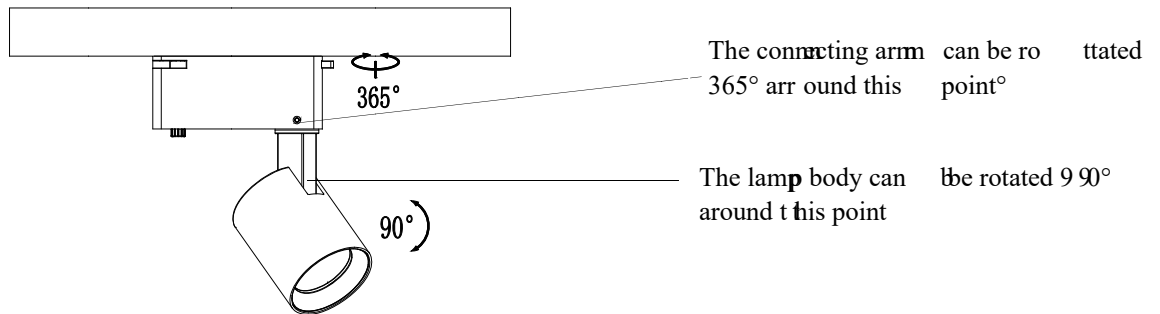

Five. Luminaire dimming

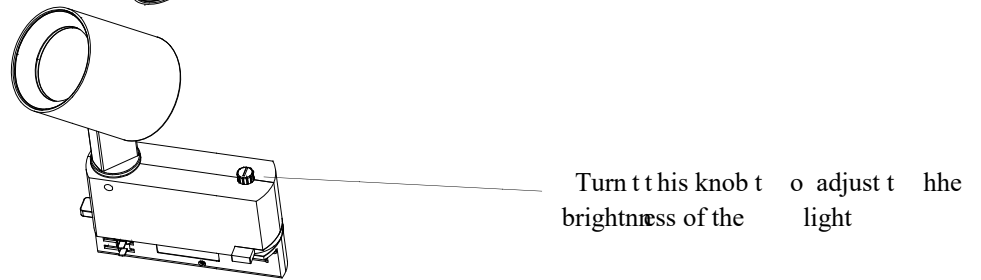

Six. Installation of accessories

1. The luminaire can be adapted to various accessories of our company. Please refer to the specifications for specific accessory models. Only the Snoot is used as an example to explain the installation method.
 - a. Take out the front frame and hang it on the lamp body. Install the condenser (or other accessories) inside the front frame, as shown on the left below;
 - b. Insert the front frame into the lamp body in the direction it was taken out, as shown in the right picture below.

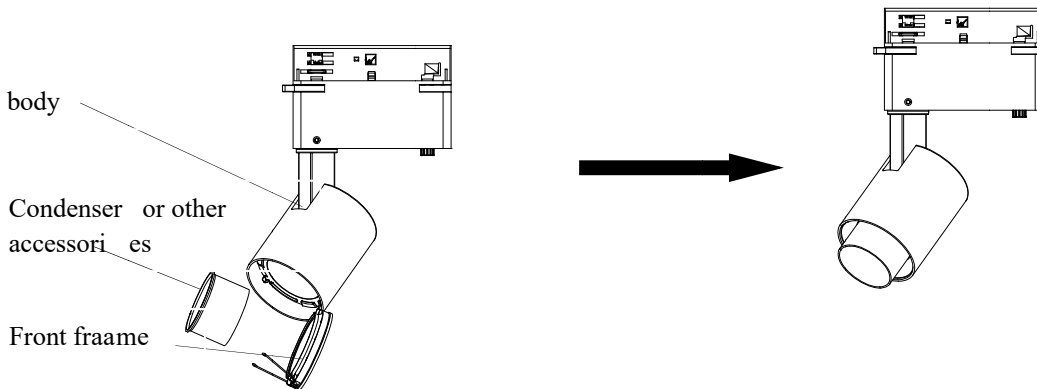

2. Glass replacement method (TL21HLM series, no replacement method for this part)
 - a. First take out the front frame, glass plate and glass as shown below:

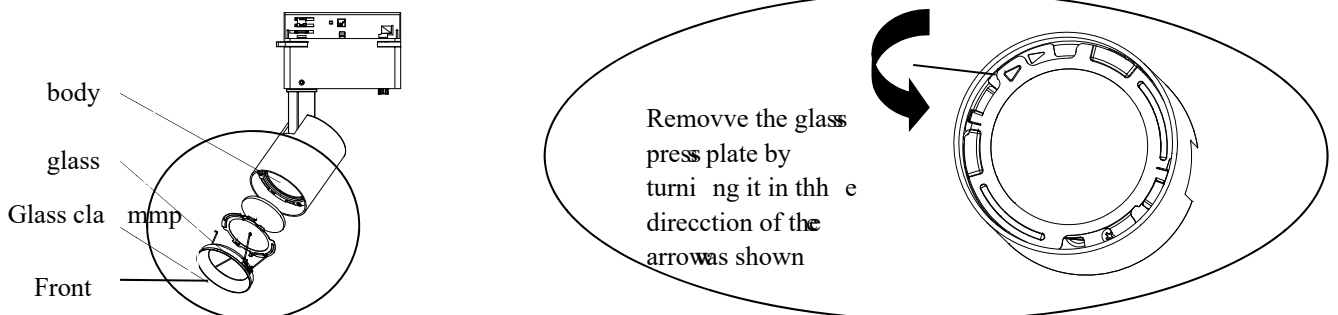

- b. Put the new glass into the lamp, and put the glass pressure plate into the lamp, and press tightly according to the following figure;
- c. Finally, install the front frame into the luminaire.

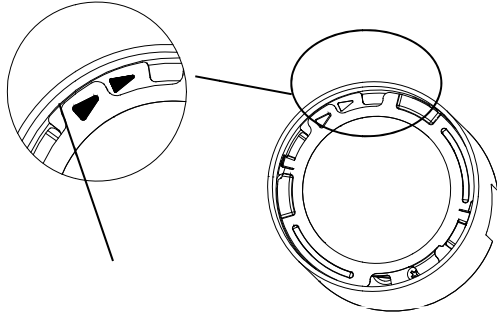

When the glass pressure plate is loaded into the lamp, pay special attention to the installation direction, align the direction of the two triangle symbols shown in the above figure, and then rotate after loading

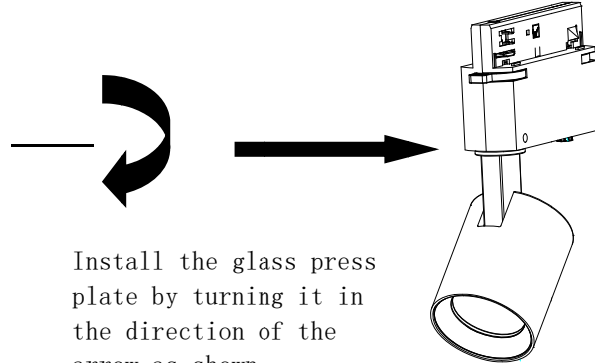

Install the glass press plate by turning it in the direction of the arrow as shown

3. warn:

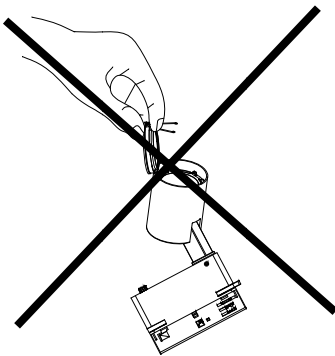

Seven. Maximum lifting weight

1. The rail system can bear the maximum weight shown in the figure below, which includes the weight of the entire suspension system.
2. A single adapter can bear a maximum load of 10kg (according to the normal installation position of the lamp load on the adapter).

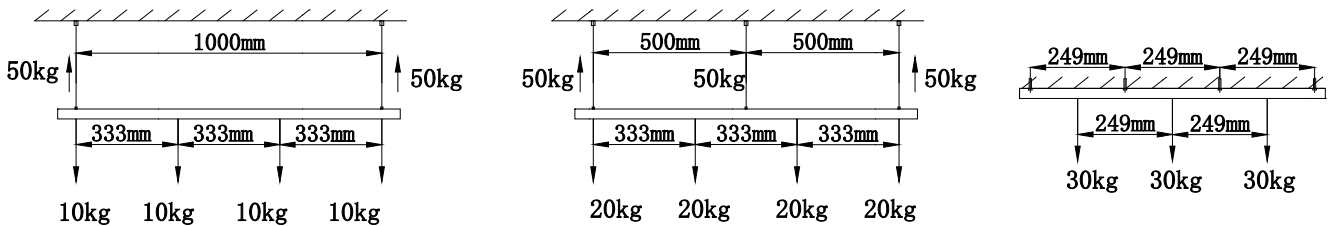

本页仅用于版本控制，请勿印刷！

序号	变更说明	变更人	变更日期
1	华格照明灯具（上海）有限公司 更改为：华格照明科技（上海）有限公司	冯巨龙	08/28/2018
2	更改上海公司地址和 LOGO	冯巨龙	09/30/2018
3	更改上海公司地址和 LOGO	吴志远	07/13/2022
4			
5			